

X 4



X 4



X 8

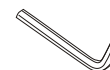

X 1



X 4

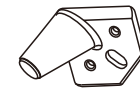
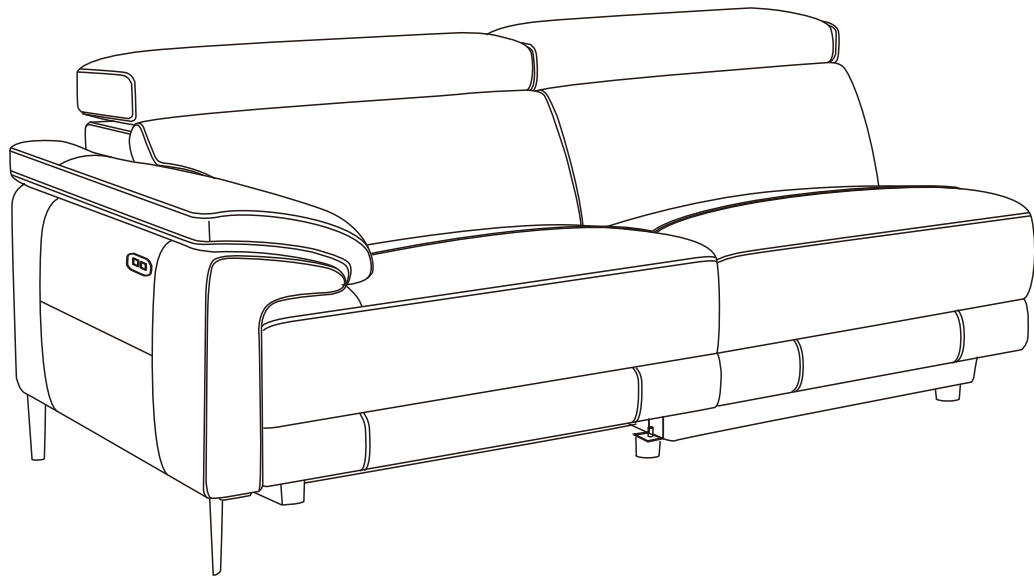

X 2



X 2



X 4

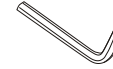

X 1



X 5

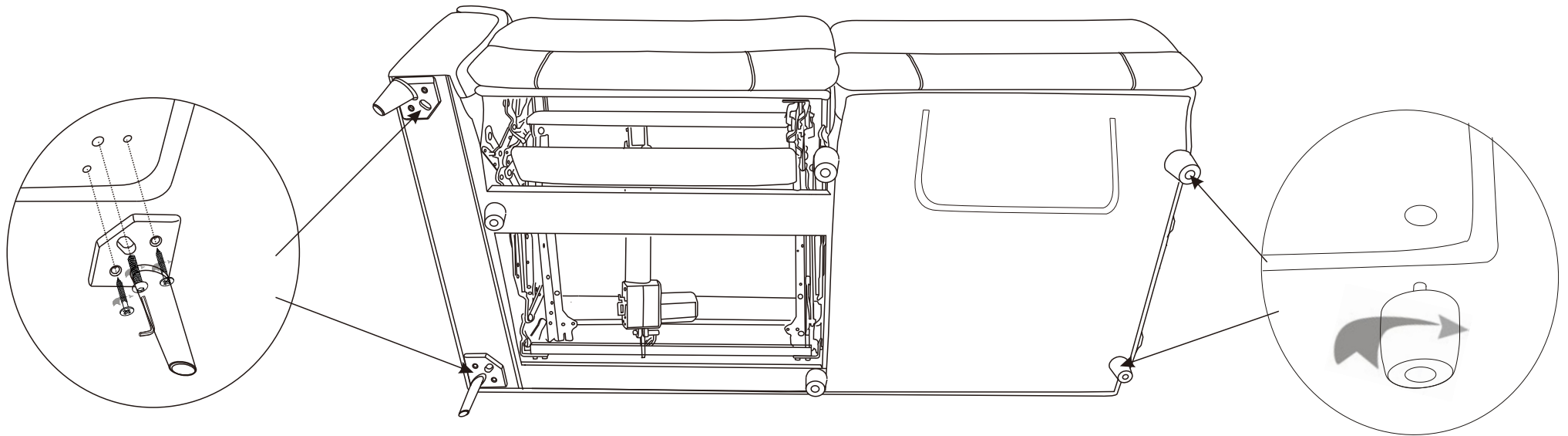

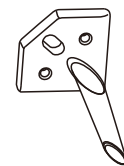
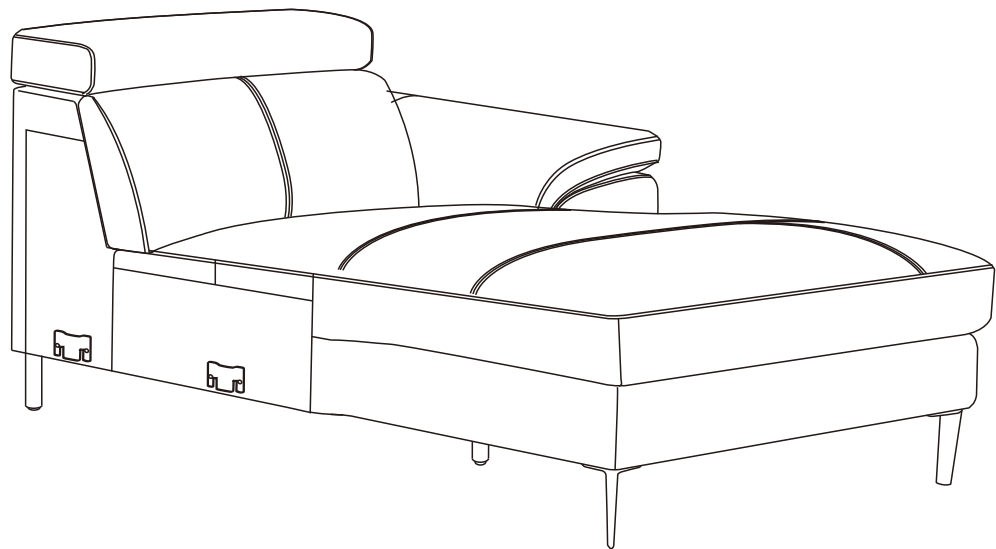

X = 3

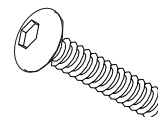

X = 3

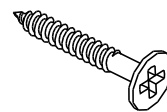

X = 6

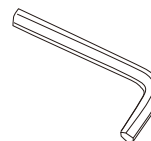

X = 1

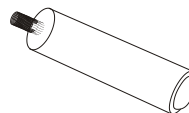

X = 2

