

# Zorro New

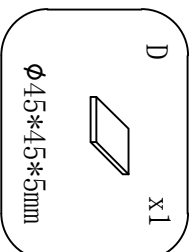
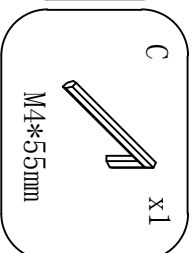
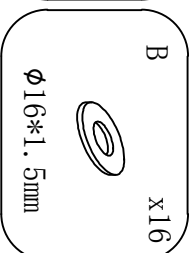
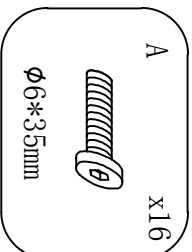
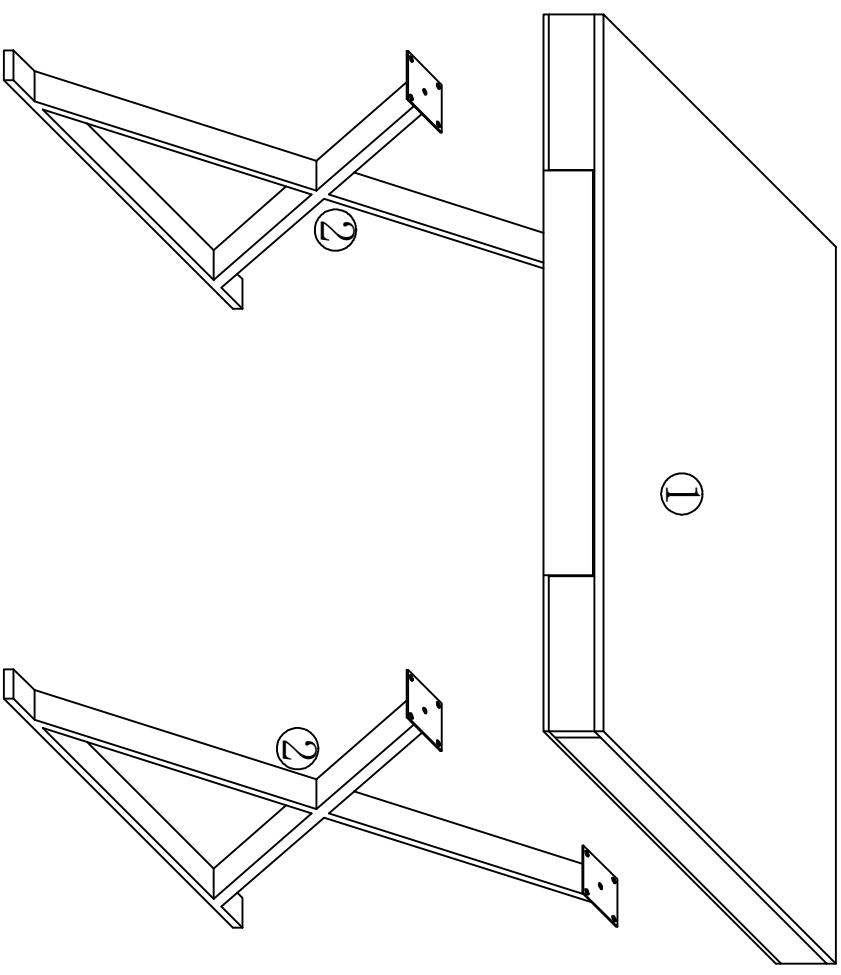
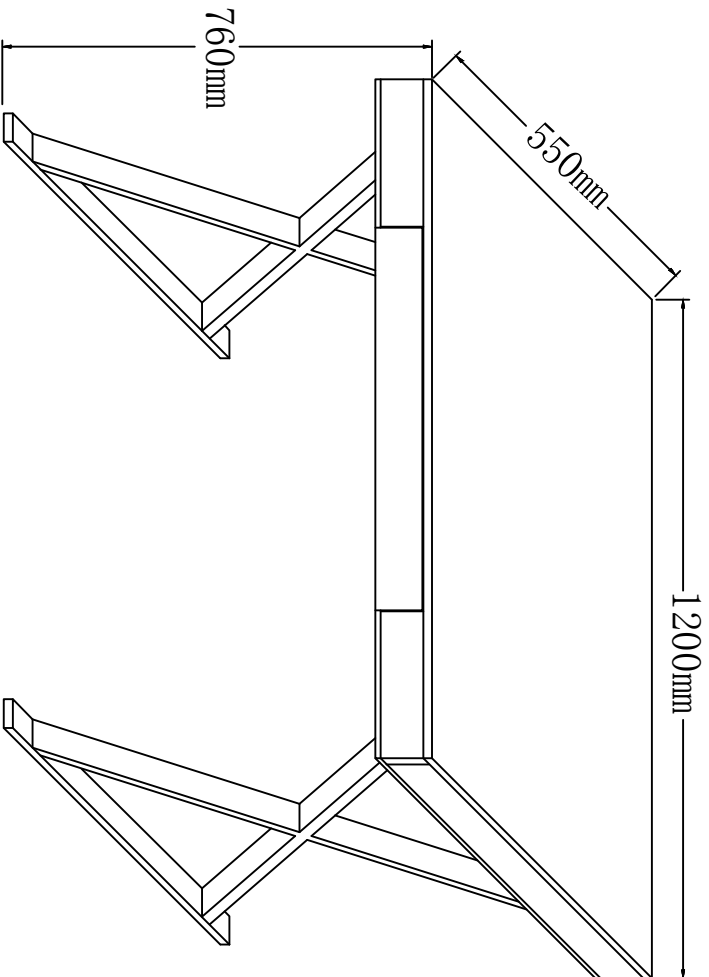

# WARNING

**FAILURE TO FOLLOW THESE BASIC STEPS CAN LEAD TO DAMAGE  
THAT IS NOT COVERED BY YOUR WARRANTY**

**1**



Read Instructions carefully.  
Check no parts are missing.

**2**

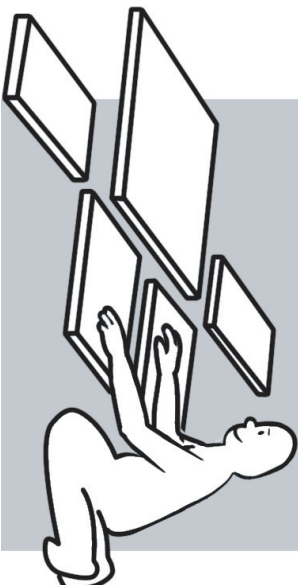

Lay out all of the components on a soft surface  
as if you were preparing to do a jigsaw puzzle.

**3**



Separate and identify each component from the  
hardware pack and rest each one in its proper  
location before fastening.

**4**



**5**

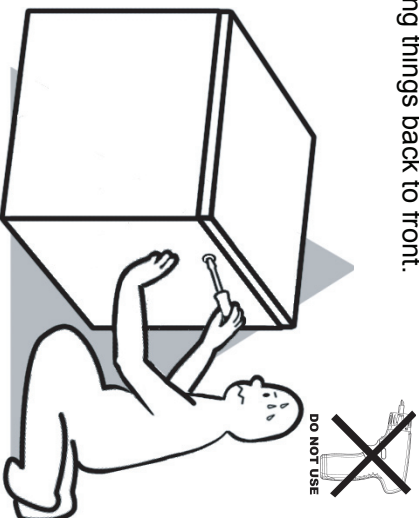

**DO NOT** fully tighten screws (leave slightly  
loose). When the item is fully assembled  
tighten the screws - but do not over tighten.

**6**



If glue is required **DO NOT** set until you are  
certain that the parts belong together.

**2**

