

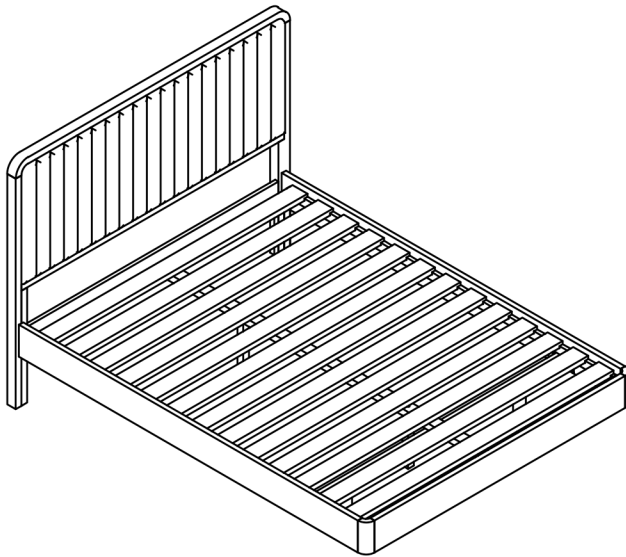











Sweden Bed







Hardware List

No.	Description			Qty
A		Allen Key	M6	1pc
B		Self-Tapping Screws	M4 x 40	39pcs
C		Hexagon Socket Screws	M6 x 15	8pcs
D		Hexagon Socket Screws	M6 x 20	4pcs
E		Washer	M6 x 12	12pcs
F		Washer	M8	2pcs
G			M8	2pcs
H			M8	1pc
I			M8*90	2pcs
J			M8	2pcs
K			8*40	4pcs
L				
M				
N				

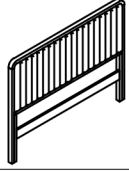
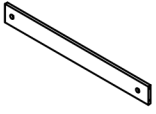
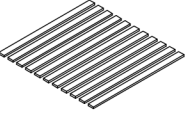
Approx: 30min Assembly Required

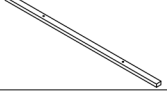
Parts List

No.	Description		Qty
1		Headboard	1pc
2		Footboard	1pc
3		Slats	13pcs
4		Side Rail (L)	1pc
5		Side Rail (R)	1pc
6		Centre Support Bar	1pc
7		Centre stand	2pcs
8		Metal Leg	1pc
9			

Tool required not included:
Screw Driver



MADE IN CHINA

Sweden (King) Bed E-23093

Step1

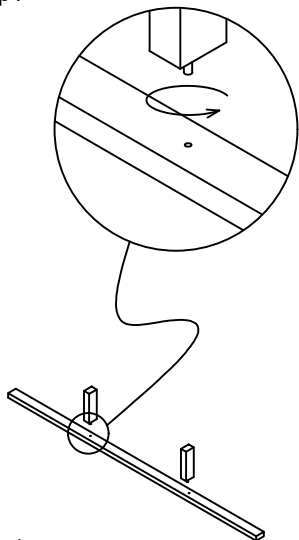

Step2

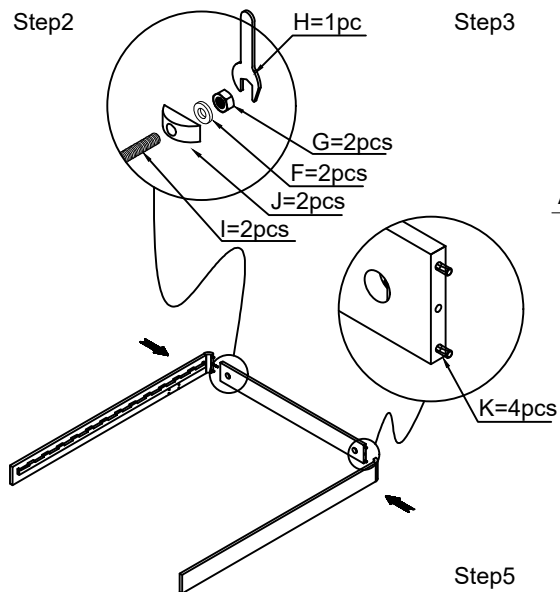

Step3

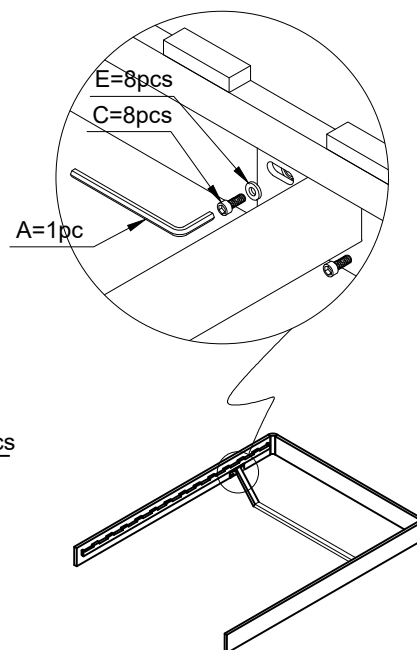

Step4

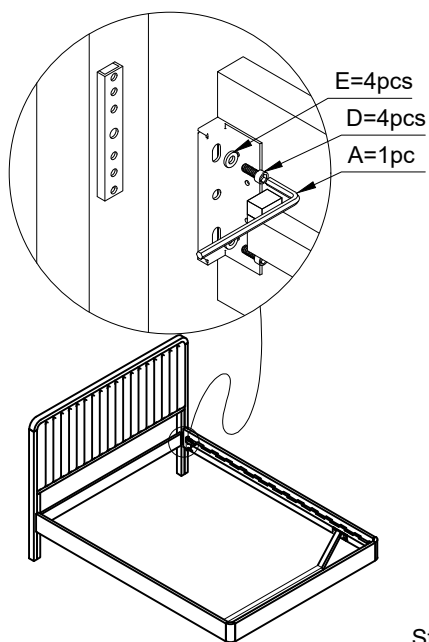

Step5

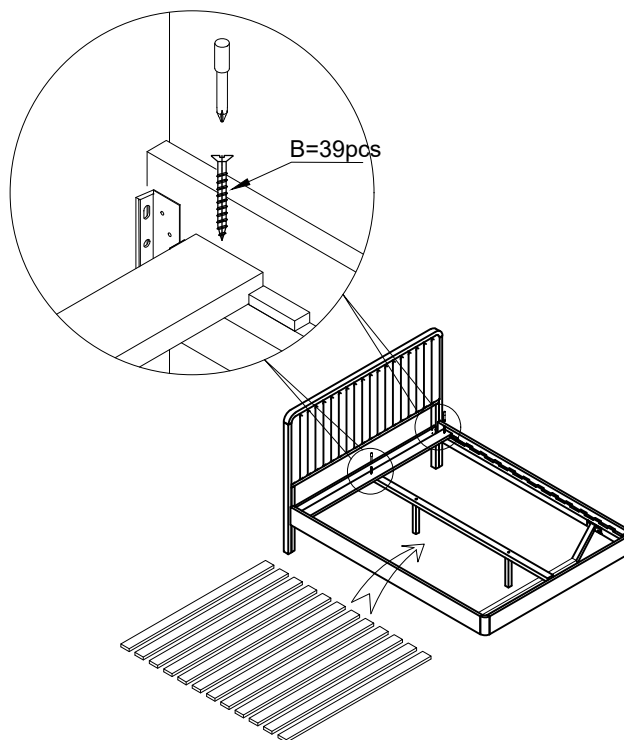

Step6

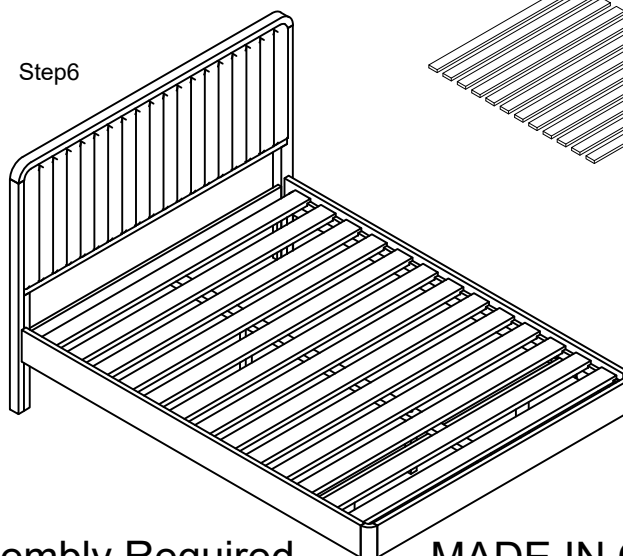

Approx: 30min Assembly Required

MADE IN CHINA