











-  X2
-  X4
-  X4
-  X16
-  X1

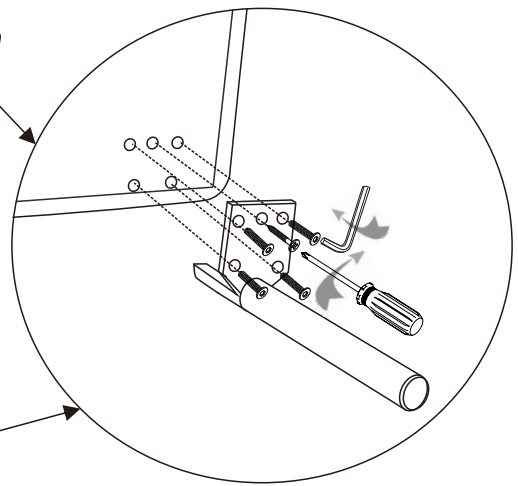
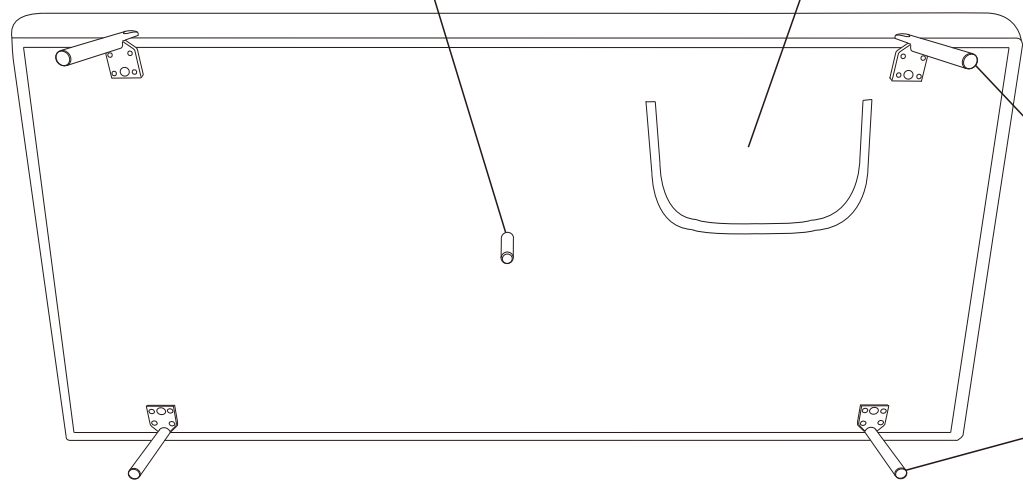
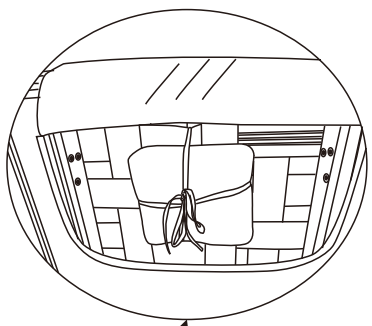
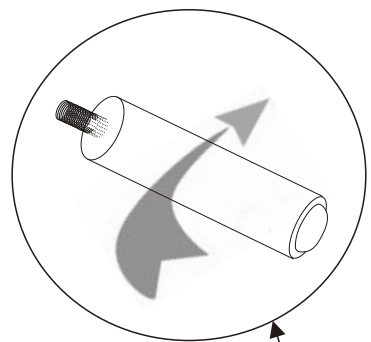
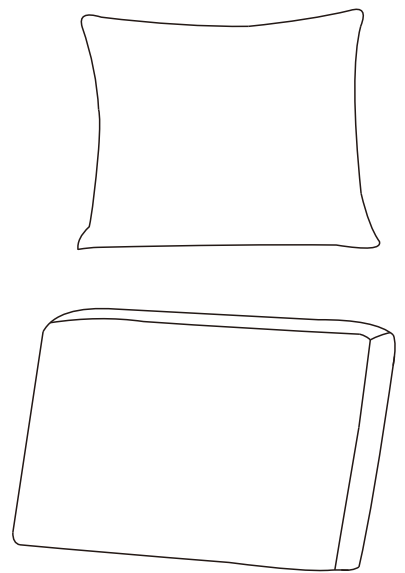
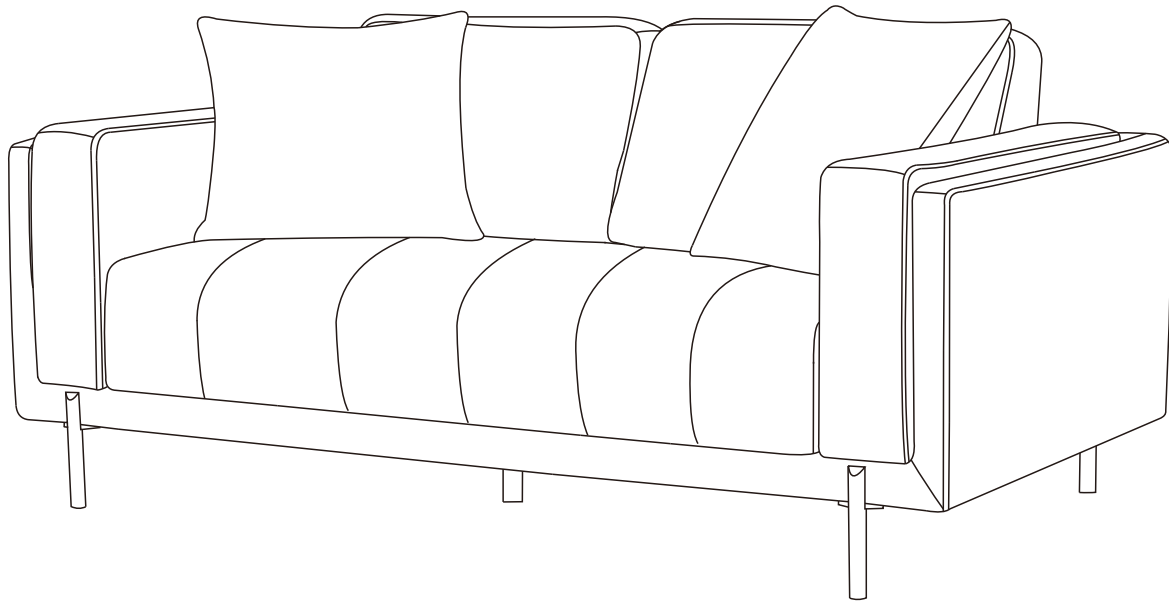

-  X1
-  X4
-  X4
-  X16
-  X1

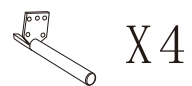
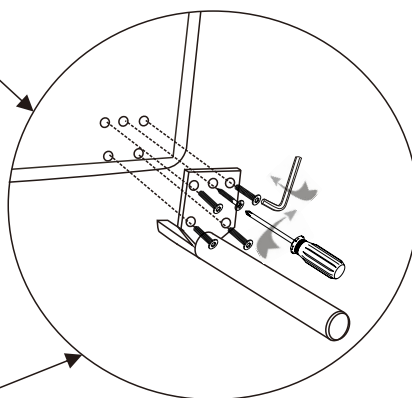
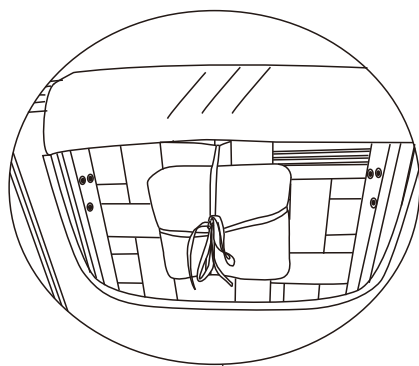
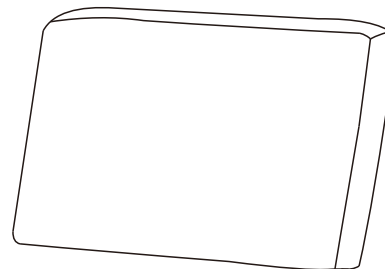
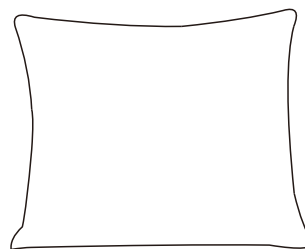
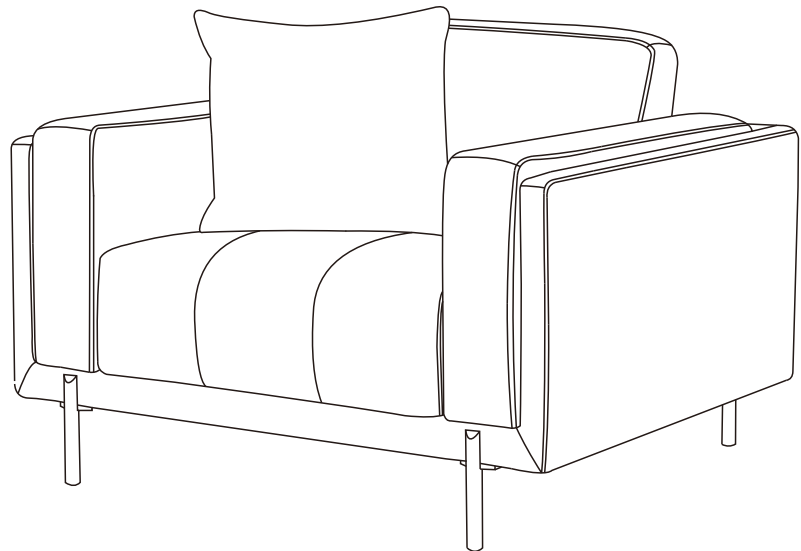

X4



X4



X16



X1