

# ASSEMBLY INSTRUCTIONS

DINING CHAIR MODEL# : UDC9013

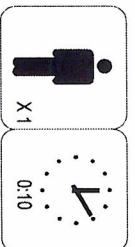

1

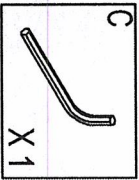
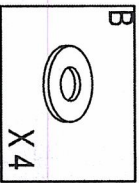
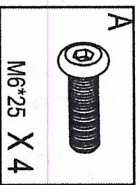
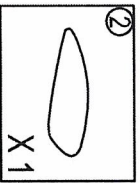
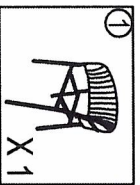
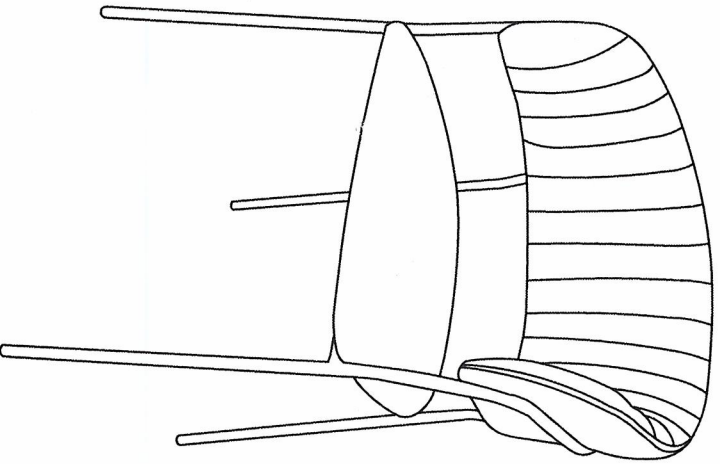